



ACTIVE BASS EXPANDER

■ GENERAL DESCRIPTION

NJM2106 is the active bass expander to be specifically used in the headphone type stereo operating at 1.5V power supply (standard). The low sound band less than 100Hz is boosted by 20 dB maximum at medium level input and at low level input, the clear feeling of listening sound, the high sound band is amplified by approx. 5dB fixed gain. These performances enable to improve dynamic range in music playback by the compact headphone stereo, the bass expansion of which is not good enough.

Thus the IC enables to get powerful and clear feeling of listening sound.

The electronic switch simply enables switching on and off of the boost, circuit, and the mute circuit.

■ PACKAGE OUTLINE

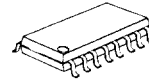

NJM2106M

■ FEATURES

- Operating Voltage (0.9~2.5V)
- Boost Value: 20dB max. (variable at and less than 100Hz)
50dB (fixed at and over 10Hz)
- Boost value in low sound band adjustable by the external resistor
- Internal mute circuit with a low click switching sound
- On & Off boost and mute circuits by electronic switch
- Low power dissipation
- Minimum external components
- Low Operating Current
- Package Outline DMP16
- Bipolar Technology

■ PIN CONFIGURATION

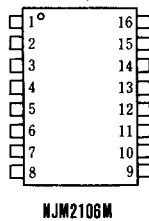

PIN FUNCTION

- | | |
|-------------------------------|--------------------------------|
| 1. Signal Input (B) | 9. Supply Voltage |
| 2. High Band Signal Input (B) | 10. Reference Voltage |
| 3. Signal Output (B) | 11. Mute Control |
| 4. HPF | 12. DET |
| 5. Boost Control | 13. LPF |
| 6. WGTF | 14. Signal Output (A) |
| 7. Boost Signal Output | 15. High Band Signal Input (A) |
| 8. GND | 16. Signal Input (A) |

4



■ BLOCK DIAGRAM

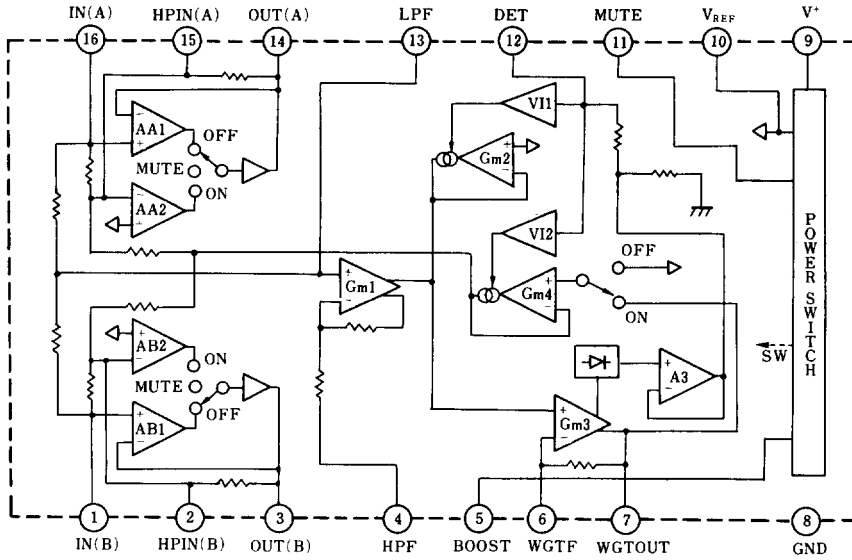

4



■ ABSOLUTE MAXIMUM RATINGS

(Ta=25°C)

PARAMETER	SYMBOL	RATINGS	UNIT
Supply Voltage	V*	5	V
Power Dissipation	P _D	300	mW
Operating Temperature Range	T _{opr}	-20 ~ +70	°C
Storage Temperature Range	T _{stg}	-40 ~ +125	°C

■ ELECTRICAL CHARACTERISTICS

(V*=1.1V, R_L=3kΩ, Ta=25°C)

PARAMETER	SYMBOL	TEST CONDITION				MIN.	TYP.	MAX.	UNIT	
		BOOST	MUTE	f(Hz)	V _{IN} (dBm)					
Operating Current 1	I _{CC1}	ON	OFF	1k	-10	-	2.1	3.5	mA	
Operating Current 2(Note 1)	I _{CC2}	OFF	OFF	1k	-10	-	1.7	3.0	mA	
Operating Current 3 (Note 1)	I _{CC3}	ON	ON	1k	-10	-	1.8	3.5	mA	
Reference Voltage (Note 1)	V _{REF}	ON	OFF	1k	-10	0.66	0.71	0.76	V	
Voltage Gain 1	G _{V1}	ON	OFF	1k	-30	-1.0	0.0	1.0	dB	
Voltage Gain 2	G _{V2}	OFF	OFF	1k	-30	-1.0	0.0	1.0	dB	
Boost Value 1	BST1	ON	OFF	50	-60	0.0	2.6	10.0	dB	
Boost Value 2	BST2	ON	OFF	50	-45	15.0	18.0	21.0	dB	
Boost Value 3	BST3	ON	OFF	50	-20	1.3	3.3	5.3	dB	
Boost Value 4	BST4	ON	OFF	10k	-20	2.5	4.5	6.5	dB	
Total Harmonic Distortion 1 (Note 1)	THD1	ON	OFF	1k	-18	-	0.1	0.6	%	
Total Harmonic Distortion 2	THD2	OFF	OFF	1k	-18	-	0.1	0.6	%	
Ripple Rejection Ratio	RR	ON	OFF	Ripple (400Hz, -40dBm) is applied on V*		40.0	43.5	-	dB	
Output Noise Voltage (Note 1)	V _{NO}	OFF	OFF	20-20kHz BPF, R _G =600Ω		-	2.7	4.0	μV	
Mute Attenuation 1	MAT1	ON	ON	50	-20	43.0	50.0	-	dB	
Mute Attenuation 2 (Note 1)	MAT2	OFF	ON	50	-20	43.0	59.0	-	dB	
Boost On Sensitivity (Note 2)	V _{BON}	ON	OFF	50	-45	Open				
Boost Off Sensitivity Voltage (Note 3)	V _{BOFF}	ON	OFF	50	-45	0.0	-	0.2	V	
Boost Off Sensitivity Current	I _{BOFF}	ON	OFF	50	-45	⑤ Pin=0V		12.0	30.0	μA
Mute On Sensitivity Voltage (Note 4)	V _{MON}	ON	ON	50	-20	0.0	-	0.2	V	
Mute On Sensitivity Current	I _{MON}	ON	ON	50	-20	⑪ Pin=0V		12.0	30.0	μA
Mute Off Sensitivity (Note 5)	V _{MOFF}	ON	ON	50	-20	Open				
Crosstalk (Note 1)	CT	ON	OFF	1k	-20	-	-27.0	-22.0	dB	

(Note 1): These parameters are guaranteed by design. The testing during the productions are not to be conducted.

(Note 2): Recommendable (5) pin to be left open, under Boost on state.

(Note 3): Recommendable (5) pin on GND under Boost off state. In case of applying voltage, recommendable to be conducted within the range of the standard value.

(Note 4): Recommendable (11) pin on GND under Mute on state. In case of applying voltage, to be conducted within the range of the standard value.

(Note 5): Recommendable (11) pin to be left open under Mute Off state. At this time, when operating IC with the current running, there might be cases of making oscillations.



■ TEST CIRCUIT

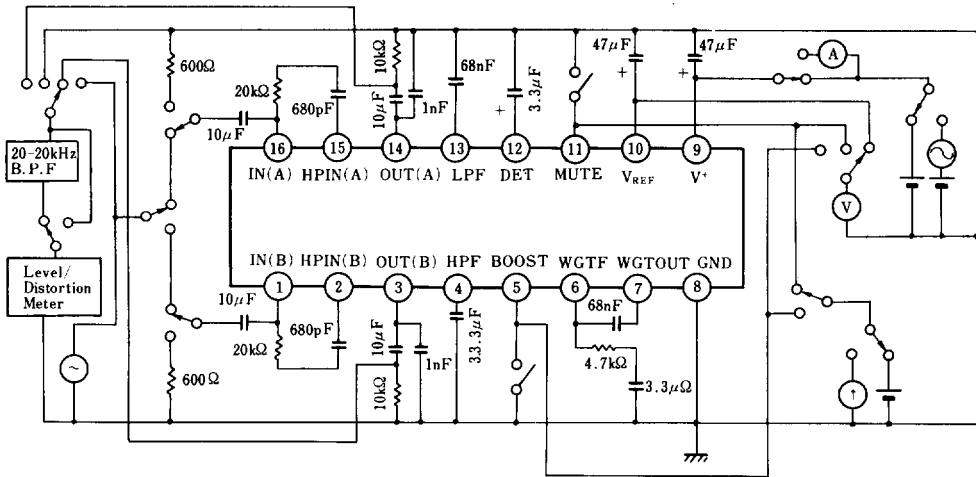

4



■ TERMINAL DESCRIPTION

PIN NO.	PIN SYMBOL	FUNCTION	PIN VOLTAGE (STANDARD)	INSIDE EQUIVALENT CIRCUIT
1 2 13 15 16	IN(B) HPIN(B) LPF HPIN(A) IN(A)	Signal Input (B) High Level Sound Signal Input (B) Externally attached R.C. Pin number at LPF High Level Sound Signal Input (A) Signal Input (A)	0.71 V 0.71 V 0.71 V 0.71 V 0.71 V	
3 14	OUT(B) OUT(A)	Signal Output (B) Signal Output (A)	0.71 V 0.71 V	
4	HPF	Externally attached R.C. pin number at HPF. Adjustment of Boost Value.	0.71 V	
5	BOOST	On/Off Switch of Boost Circuit. Open: On GND: Off	ON State 0.75 V	

4



■ TERMINAL DESCRIPTION

PIN NO.	PIN SYMBOL	FUNCTION	PIN VOLTAGE (STANDARD)	INSIDE EQUIVALENT CIRCUIT
6	WGTF	Externally attached R.C. Pin number of weighting filter Amp.	0.71 V	
7	WGTOUT	Boost Signal Output	0.71 V	
10	V _{REF}	Reference Voltage	0.71 V	
11	MUTE	On/Off Switch of Mute Circuit Open: Off GND: On	Off State 0.65 V	
12	DET	Control Voltage Output Pin		



■ PRINCIPLE OF OPERATION

NJM2106 is consists of the circuit of high sound band amplifier, low sound band amplifier, the circuit to add amplified signals on the main signal, and the mute which shuts off the signal.

Higher sound band element: It is supplied to 2 and 15 pins after passing through external R & C. This signal plus main signal input in 1 and 16 pins is output from 3 and 14 pins.

Low sound band element: It is extracted by bandpass filter consisted of internal resistors in 1 & 16 pins, external capacitor in 13 pin and Gm1 upon input in 1 and 16 pins. This signal goes through Gm4 after amplified in narrower bandwidth at Gm3, and output at 3 and 14 pins after added by the addition circuit of the main signal. The above circuits operate as the bigger signal, the larger amplification. Gm3 has one more output. The output signal rectified by all-wave rectifying circuit becomes controlled voltage by being balanced by external 12 pin capacitor. The controlled voltage controls the gain at Gm4 and Gm2 operates as limiter circuit to avoid saturation as the input signal becomes larger than some certain level. When the boost is off, the input signals at 1 & 16 pins output as they are by the gain 1 amplifier. When the mute is on, the signal is shut off by output circuit input connected to V_{REF} .

■ APPLICATION NOTE

1. Power supply

The NJM2106 is a single power supply IC operated at the voltages from 0.9V to 2.5V. The standard voltage generated at 10 pin is fixed at about 0.71V considering the low voltage operation. As such head room is not expandable even though the supply voltage is increased. Accordingly, the IC is suitable for single supply voltage operation by one dry cell battery and at 3V setting, the signal level is required to be lowered.

2. Operation mode control

The NJM2106 functions are controlled by internal electronic switch. the switch of the operation modes is designed to be controlled by either connecting or opening on & off of the boost and mute at 2 terminals. So, the use of mechanical switch is recommended. the following precaution should be taken in case of using NPN transistor to control.

(1) The voltage should be loaded at 5 & 11 pins lower than 0.2V on 9 & v^+ and higher than 0.4V on 8 pin(GND).

(2) As 11 pin, mute control, is not digitally controlled, in case of switch on for mute, the voltage should be less than 0.2V, and in case of off, it should be open as much as possible. In case that it cannot be opened at switch off, the current coming into 11 pin should be less than 2uA. In this case outputs at 3 and 14 pins sometime oscillate, so stop it by putting the capacitor (1000 through 5000 pF) between 3/14 pins and ground. When the mute is on, 3 & 14 pins are in not signal position and generates the same voltage (approx. 0.71V) of that of V_{REF} .

3. Control of boost volume in high sound band

The boost is obtained by adding the high sound band element taken out by HPF at A and B channels to the main signal.

The signal in high sound band is boosted by the following equations.

$$\text{Gain: } GH = R_7 \cdot \left\{ \frac{1}{R_8} + \frac{1}{(R_9 + 1j\omega C_5)} \right\}$$

$$\text{Cutoff Frequency: } f_{HH} = 1 / (2\pi R_9 \cdot C_5)$$

In one of the application cases shown at right,

$$f_{HH} = 11.7\text{kHz}$$

Gain at 20kHz is around 6 dB.

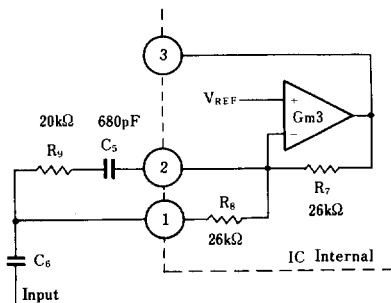

4. Control of boost volume in low sound band

The boost is controlled by bandpass filter by LPF/HPF which takes out low sound band of IN(A) and IN(B), by gain control circuit and the circuit generating the control signal and by headroom control circuit. As the band and gain of the above filter are set up by the external C & R, low sound amplification effect is adjusted by external constant.

The foolwings are referenced to when adjusting.

- (1) LPF cutoff frequency to be set up by R1, internal resistor and C1, external capacitor.

Cutoff frequency: $F_{L1} = 1 / (2\pi R_1 \cdot C_1)$

- (2) HPF cutoff frequency and gain to be set up by:

Internal resistor, R2 & R3, and external resistor, R4, and external capacitor, C2.

Gain: $G = 1 + R_2 / (R_3 + R_4 + 1/j\omega C_2)$

Cutoff Frequency: $f_{H1} = 1 / \{ 2\pi \cdot (R_3 + R_4) \cdot C_2 \}$

- (3) Cutoff frequency and gain of the amplifier with weighting function

They are set up by internal resistor, R5, external resistor, R6 and external capacitor, C3 as shown in the following equations.

Gain: $G = 1 + j\omega C_3 \cdot R_5 / (1 + j\omega C_3 \cdot R_6) / (1 + j\omega C_4 \cdot R_5)$

Cutoff Frequency: $F_{L2} = 1 / (2\pi \cdot R_6 \cdot C_3)$

$F_{H2} = 1 / (2\pi \cdot R_5 \cdot C_4)$

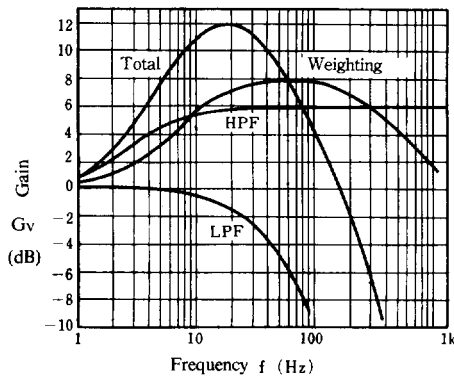
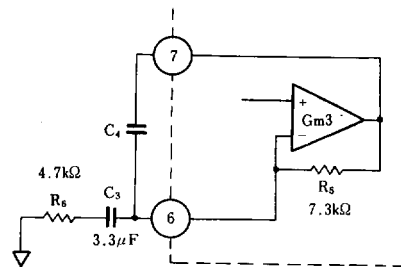
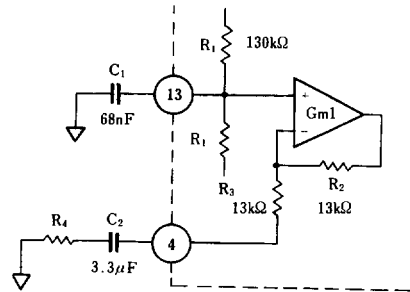

4



TYPICAL CHARACTERISTICS

Operating Current, Reference Voltage vs. Operating Voltage

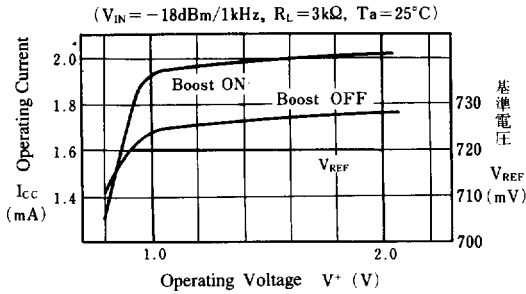

Output Amplitude vs. Operating Voltage

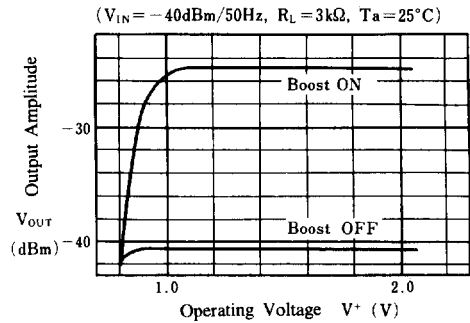

Output Amplitude vs. Input Amplitude

(Boost OFF, $V^+ = 1.1\text{V}$, $f = 1\text{kHz}$, $R_L = 3\text{k}\Omega$, $T_a = 25^\circ\text{C}$)

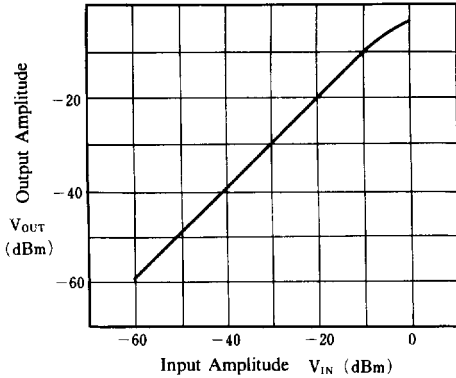

Output Amplitude vs. Input Amplitude

(Boost ON, $V^+ = 1.1\text{V}$, $R_L = 3\text{k}\Omega$, $T_a = 25^\circ\text{C}$)

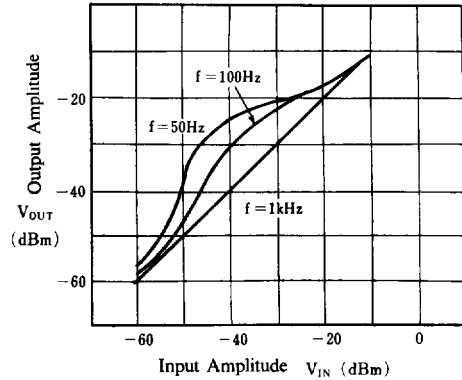

Output Distortion vs. Input Amplitude

(Boost OFF, $V^+ = 1.1\text{V}$, $R_L = 3\text{k}\Omega$, $T_a = 25^\circ\text{C}$)

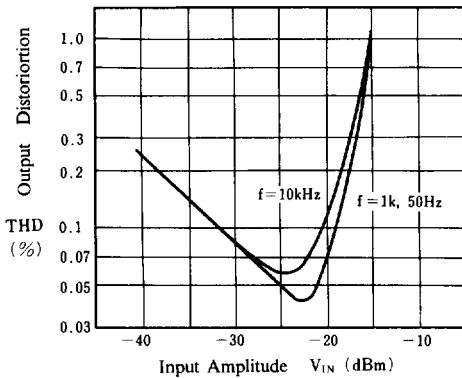

Output Distortion vs. Input Amplitude

(Boost ON, $V^+ = 1.1\text{V}$, $R_L = 3\text{k}\Omega$, $T_a = 25^\circ\text{C}$)

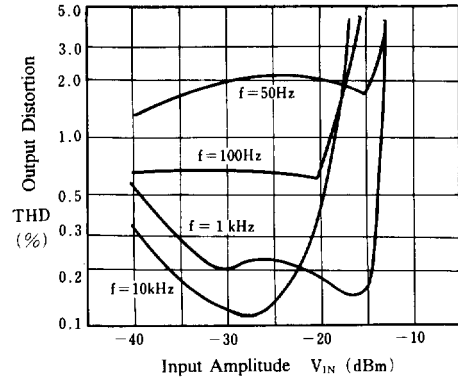



■ TYPICAL CHARACTERISTICS

Output Amplitude vs. Frequency

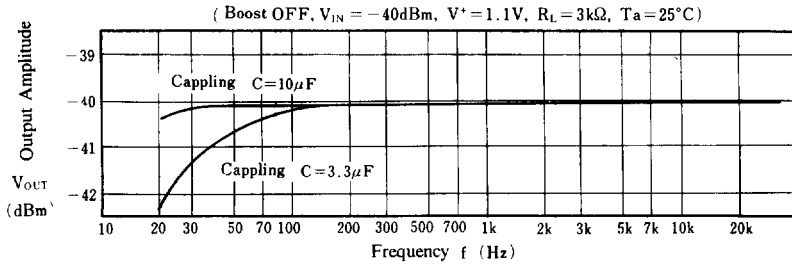

Output Amplitude vs. Frequency

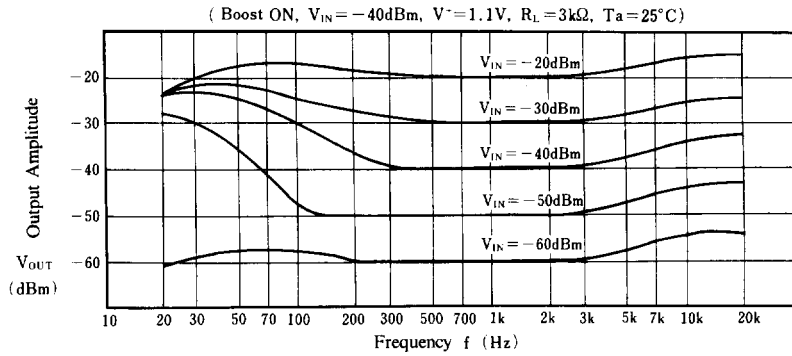

Crosstalk vs. Frequency

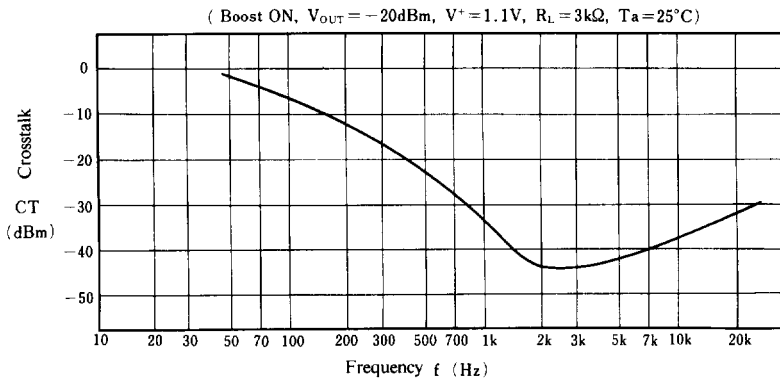

4



■ TYPICAL CHARACTERISTICS

Ripple Rejection Ratio vs. Operating Voltage

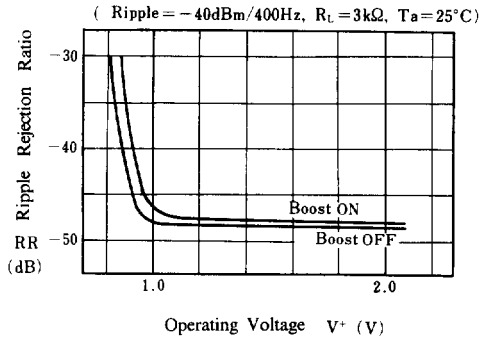

Mute Attenuation vs. Operating Voltage

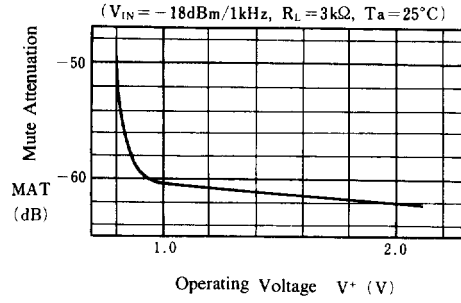

Output Amplitude, Distortion vs. Load Resistor

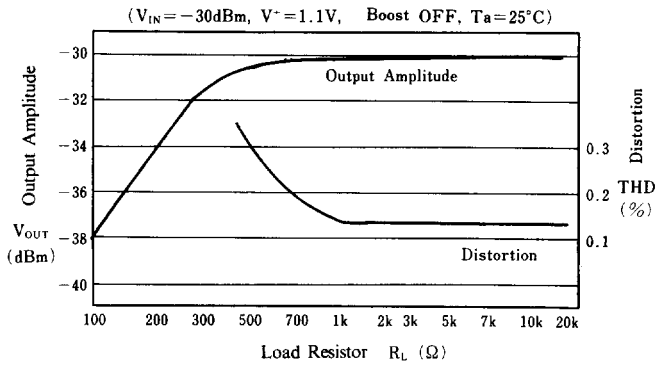

■ APPLICATION CIRCUIT

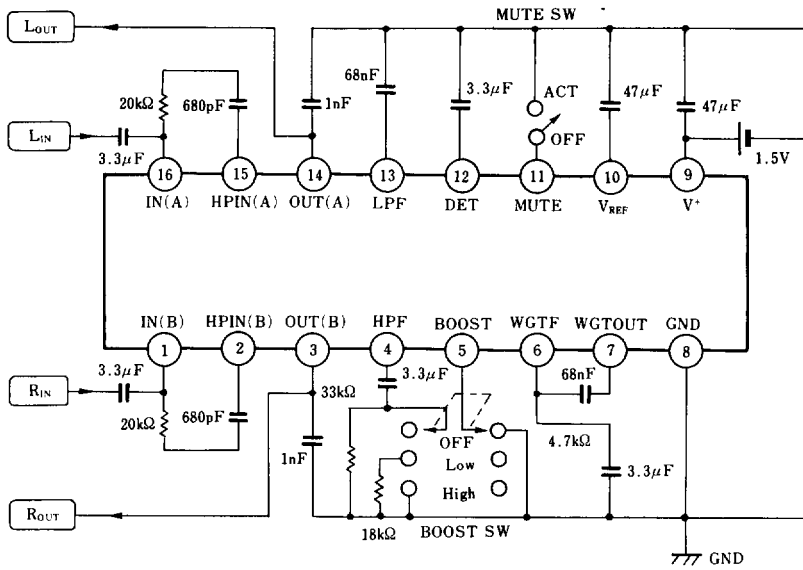

4